

LED



Max  
2W

IP20

1W 350 ma  
2w 700 ma

SEGNALASSI IN GESSO  
PLASTER MARKER

1

SCOLLEGARE LA TENSIONE  
NO ELECTRICITY

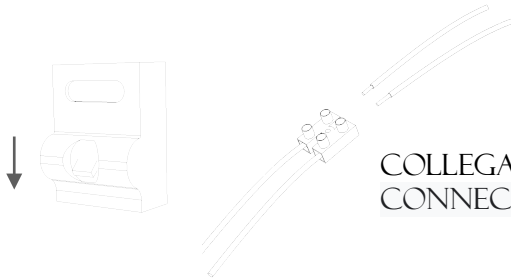

COLLEGARE I CAVI  
CONNECT THE WIRES

2

TAGLIO , INSERIRE E AVVITARE  
CUT, INSERT AND SCREW

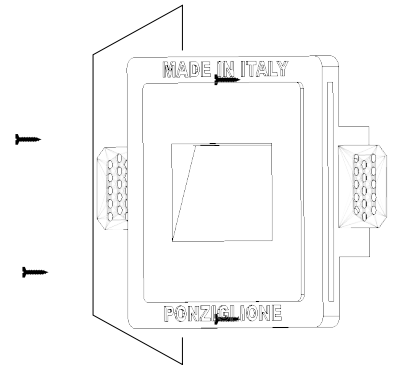

3

STUCCARE/PUTTY

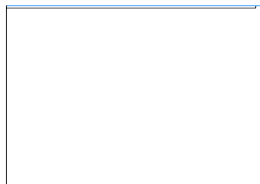

4

INSERIRE LED  
INSERT LED

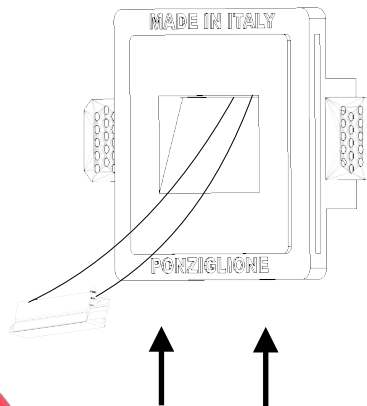

MISURE / MEASURES

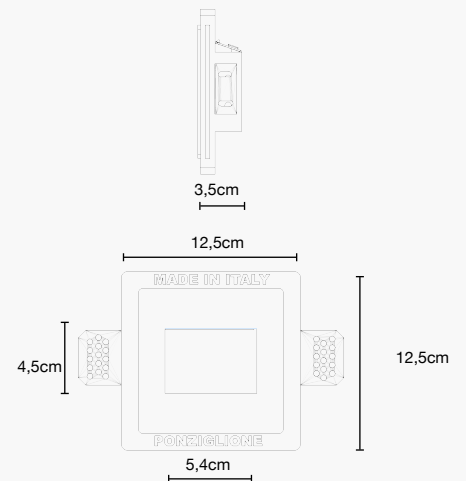

ITA

MATERIALE GESSO CERAMICO NATURALE V TIPO EXTRA BIANCO ,IDEATA E CREATA PER AVERE UNA SUPERFICIE LISCIA E SENZA IMPERFEZIONI SEMPLIFICANDO IL LAVORO DI TINTEGGIATURA ,I NOSTRI PRODOTTI VENGONO LAVORATI A MANO DA MAESTRI ITALIANI RENDENDOLI VERE E PROPRIE OPERA D'ARTE.

ENG

NATURAL CERAMIC PLASTER MATERIAL V TYPE EXTRA WHITE, DESIGNED AND CREATED TO HAVE A SMOOTH SURFACE WITHOUT IMPERFECTIONS BY SIMPLIFYING THE PAINTING WORK, OUR PRODUCTS ARE HANDCRAFTED BY ITALIAN MASTERS MAKING THEM REAL WORKS OF ART.

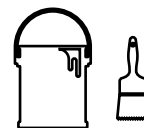

MATERIALE FACILMENTE  
VERNICIATILE  
EASILY PAINTED MATERIAL

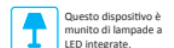

Questo dispositivo è compatibile con lampadine di classi energetiche

874/2012